



# INSTRUCTION MANUAL

## ■ OIL-FREE SCROLL BASE MOUNT ENCLOSURE AIR COMPRESSOR

### SLBE-2/3/5

### SLBE-2H/3H/5H

Thank you for purchasing our oil-free scroll air compressor.

- Before operation, be sure to read this instruction manual thoroughly for safe and efficient use for a long operating lifetime.
- After reading it, store in a convenient place for immediate and future reading.

Before use, be sure to fill in the blank spaces below for future repair and after service.

MODEL	
SERIAL No.	
Purchased from	
Date of purchase	
Date of use	

# Important information-Safety precautions

## ■ Important information

Be sure to read and understand this instruction manual.



The operator shall be fully conversant with the requirements stated within this instruction manual including important warnings, cautions and operation.

The marks and symbols have the following meanings.





Keep this booklet in an appropriate place for immediate reference.

- Indications of warnings and cautions

 <b>WARNING</b>	Indicates a potentially hazardous situation which, if not avoided, will result in serious injury or loss of life.
 <b>CAUTION</b>	Indicates a potentially hazardous situation which, if not avoided, may result in minor or moderate injury or property damage.

- Examples of warnings and cautions

	Indicates「You must be careful」. We will explain briefly in or near the symbol. (The example on the left is [Be careful about electric shock])
	Indicates「You must not do」. We will explain briefly in or near the symbol. (The example on the left is [Do not touch]).
	Indicates 「You must do」. We will explain briefly in or near the symbol. (The example on the left is [Be sure to ground it]).

\* We shall not be responsible for any injury or damage caused by disregard of warnings, cautions or instruction.

## Important information - Safety precautions

### ▪ Safety precautions

## **WARNING**



### **Install in a safe area.**

Install in an area which is free of volatile, flammable gases or organic solvents.

They can cause explosion or fire.



### **Never install outdoors.**

Do not install outdoors (This compressor is not water-proof)

If water splashes on electric equipment, it can cause electric shock or fire.



### **Turn off main electric source.**

Be sure to turn off main electric source before inspection or wiring job.

If not, it can cause electric shock or serious bodily injury.



### **Ask qualified electrician.**

Ask qualified electrician to perform electric wiring job.

If not, it can cause electric shock or fire.



### **Be sure to ground.**

Be sure to do the grounding job.

If not, it can cause electric shock or fire.



### **Never use to compress other than air.**

If done, it can cause explosion, fire or damage.



### **Never use with respiratory equipment which directly intake compressed air.**

If done, it can cause serious bodily injury.

## Important information - Safety precautions

---

### **WARNING**

 **Never use with equipment which is directly concerned with human life.**

If done, it can cause serious bodily injury.

 **Never touch**

Never touch turning section (fan, pulley and belts) while main electric source is turned on.

If done, it can cause serious injury including entanglement of fingers or hands.

 **Release pressure**

Be sure to release pressure from air receiver and make sure there is no pressure inside before conducting any maintenance and inspection.

If not, parts can scatter and can cause serious injury.

 **Conduct maintenance and inspection**

Conduct maintenance and inspection according to maintenance standards.

If not, it can cause fire and failure.

## Important information - Safety precautions

---

### **CAUTION**

 **Use at ambient temperature of 36 degree F to 104 degree F (during operation)**

Drain will freeze at less than 36 degree F and cause failure.  
More than 104 degree F will cause shorter lifetime or damage.

 **Use at an area which is free of dirt or dust.**

If done, it can cause failure.

 **Use at an area which is free of corrosive gas.**

If done, it can cause failure.

 **Ask specialist to perform repairs.**

If not, it can cause failure and shorter lifetime.



**Never touch.**

Never touch each section of compressor during operation or soon after operation.

If done, it can cause burns.



**Never alter the compressor.**

If done, it can cause damage or shorter lifetime.

 **Use genuine parts.**

Be sure to use our genuine parts when replacing parts during maintenance.

If not, it can cause failure or shorter lifetime.

# Contents

## Important information-Safety precautions

- Important information -----1
- Safety precautions-----2

## Contents

- Contents -----5

## Before use

- Check the product -----6

## Installation

- Precaution about installation -----7
- Piping -----8
- Electrical wiring -----9

## Operation

- Before start up -----11
- Start-up and operation -----11

## Maintenance and inspection

- Maintenance standards -----13
- How to carry out maintenance -----15

## Troubleshooting guide

- Compressor -----16

## Specifications

- Compressor specifications -----17

## Appendix

- Outer dimensions -----18
- Circuit diagram -----19

## Warranty

- Warranty and remedies -----22

# Before use

- Inspect the product
  - Check that model name of the product is as you ordered.

Model name description;

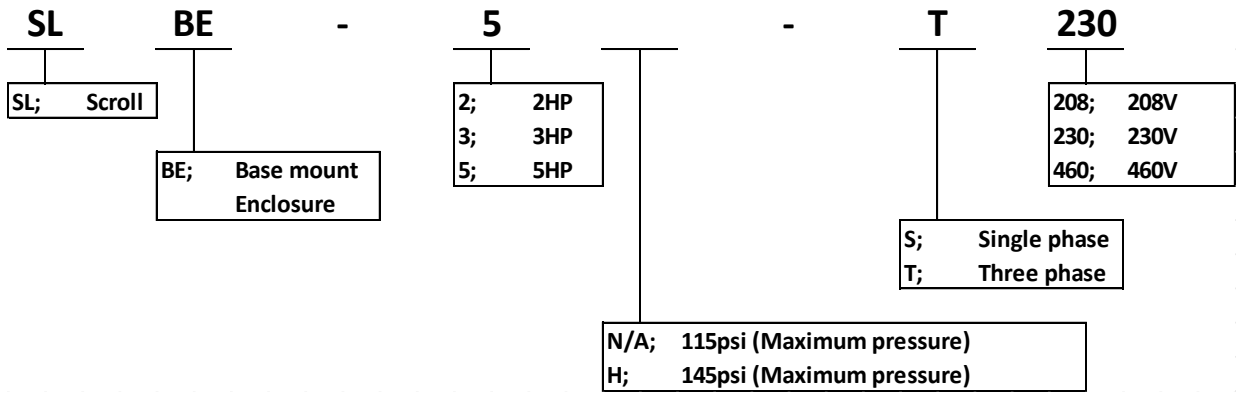

- Check that there is no deformity or damage which occurred during shipment. Any shipping damage must be immediately filed with the freight carrier.
- Check that the following accessories are included.
  - Compressor instruction manual
  - Scroll pump instruction manual

# Installation

---

- Precautions about installation



## WARNING

Do not use in an area which is exposed to rain, steam or high humidity.

High Humidity can cause electric shock or fire.

Do not install in an area with corrosive gas (ammonia, acid, salinity, ozone gas and sulfur dioxide).

If done, it can cause shorter lifetime.



## WARNING

Install in an area which is free of explosive, flammable gases or organic solvents.

If done, it can cause explosion and fire.



## Ambient temperature

Use at ambient temperature of 36 degree F to 104 degree F.

Less than 36 degree F will cause failure or freezing.



## CAUTION

Install this product on a flat floor.

If not, it may cause vibration and noise and shorten life.



## CAUTION

Install in an area which is free of dust.

Dust can cause increase temperature and wear, resulting in shorter lifetime and failure.



# Installation

- Installation space

Secure the space around compressor for safe, inspection and maintenance.

Installation space (inch)	
Above	24 inches
Each Side	20 inches

- Ventilation

When using in totally closed room, install fan for ventilation.

Model	British Thermal Unit BTU
SLBE-2**	5160
SLBE-3*	7570
SLBE-5*	12730

- Piping

- Do not use any steel pipe and a smaller size than the compressor outlet connection.
- If the compressor stops and starts frequently, we recommend you to install air receiver. (option)
- When there is any riser piping, be sure to install drain collector or drain valve.



## WARNING

Be sure to install the check valve on the downstream piping from the compressor outlet.  
If not, it can cause serious failure.







## WARNING

Be sure to install the safety valve on the downstream piping from the compressor outlet.  
The pressure setting of the safety valve must be no higher than the maximum working pressure of the tank and maximum designed pressure of the compressor.  
If not, it can cause serious failure.

# Installation

- Electrical wiring
  - Precautions about wiring

	<p><b>Turn off main electric source.</b></p> <p>Be sure to turn off main electric source before inspection or wiring job.</p> <p>If not, it can cause electric shock or serious bodily injury.</p>
	<p><b>Ask qualified electrician.</b></p> <p>Ask qualified electrician to perform electric wiring job.</p> <p>If not, it can cause electric shock or fire.</p>
	<p><b>Be careful about wiring.</b></p> <p>Do not use cable of less than designated size.</p> <p>If done, overheat of cable can cause fire.</p>
	<p><b>Be sure to ground.</b></p> <p>Be sure to do the grounding job.</p> <p>If not, it can cause electric shock or fire.</p>

- Wiring

Be sure to use the ring terminal to firmly connect the electric source to the designated place of the motor terminal box. Please refer to the rating plate on the motor.

- 115V/208V-230V, 1PH, 60Hz

Motor Size HP	Power V/PH	Motor Load FLA	Non-time Delay Fuse A	Time Delay Fuse A	Inverse-time circuit breaker A
2	115V/1PH	24	60	45	60
	208V/1PH	13.2	35	25	35
	230V/1PH	12	30	25	30

# Installation

○ 208V-230V/460V, 3PH, 60Hz

Motor Size HP	Power V/PH	Motor Load FLA	Non-time Delay Fuse A	Time Delay Fuse A	Inverse-time circuit breaker A
2	208V/3PH	7.5	20	15	20
	230V/3PH	6.8	20	15	20
	460V/3PH	3.4	15	15	15
3	208V/3PH	10.6	30	20	30
	230V/3PH	9.6	25	20	25
	460V/3PH	4.8	15	15	15
5	208V/3PH	16.7	45	30	45
	230V/3PH	15.2	40	30	40
	460V/3PH	7.6	20	15	20

# Operation

- Before start up
  - Make sure all safety warnings, labels, and instructions have been read and understood before continuing.
  - Make sure any shipping materials, brackets, etc. are removed.
  - Check that the electric power source and ground have been firmly connected.
  - Make sure all pressure connections are tight.
  - Check to be certain all safety relief valves, etc., are correctly installed.
  - Check that all fuses, circuit breakers, etc., are the proper size.
  - Make sure the inlet filter is correctly installed.
  - Check that the drain valve is closed.
  
- Start-up and operation
  - Switch the electric source breaker on.
  - Turn the pressure switch on.
  - Open the discharge valve completely.
  - Check that the compressor operates without excessive vibration, unusual noises or leaks.
  - Close the discharge valve completely.
  - If the pressure does not rise on a three phase unit, stop the unit and turn the electric source breaker off and exchange the L1 and L2 connections inside the control box.

 **CAUTION**

In case of reverse rotation, the pressure does not rise and abnormal sound is heard. Immediately, turn the pressure switch off and turn the main electric source breaker off. And, exchange the L1 and L2 connections inside the control box.

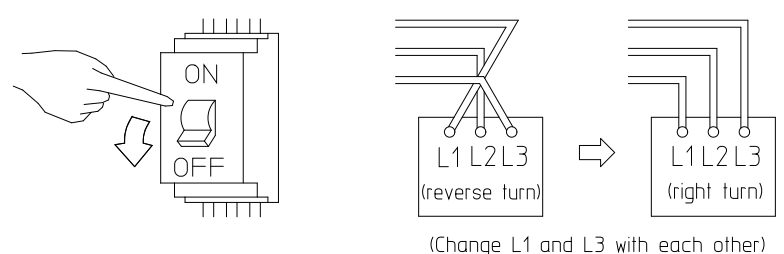

(Change L1 and L3 with each other)

# Operation

---

- Check the discharge pressure. Also make sure the compressor stops at the setting pressure as below.

Model	Cut-out pressure (psi)
SLBE-2, SLBE-3, SLBE-5	115
SLBE-2H, SLBE-3H, SLBE-5H	145

- Check the discharge pressure. Also make sure the compressor starts as pressure drops.

Model	Cut-in pressure (psi)
SLBE-2, SLBE-3, SLBE-5	85
SLBE-2H, SLBE-3H, SLBE-5H	115

# Maintenance

Following maintenance is required at following interval. This interval is based on condition where ambient temperature is at around 86 degree F. If your location is warmer or running condition is severer, maintain at a shorter period. If warmer shorten the period approx. 30% from our recommendation at every 9 degree F. **Standard maintenance period is not our warranty period.**

▪ **Standard maintenance period**

- For 115psi models (SLBE-2\*, SLBE-3 and SLBE-5)

**Maintenance is to be done according to operating hours or period whichever comes first.**

Item	Details	Maintenance period (every hours or periods)							
		Daily	Every 400 Every 2 months	Every 2,500 yearly	Every 5,000 Every 2 years	Every 10,000 Every 4 years	Every 20,000 Every 8 years	30,000 12 years	
Drain	Air receiver	○							
Noise, vibration	Check	○							
Air intake filter	Clean		○	●					Whenever it is dirty
Safety valve	Check function		○						
V belt	Tension/replace		○ initial only	○		●☆			Not slack or loose
Pressure gauge	Check			○					
Magnetic switch	Check or replace				○☆	●☆			
Motor, insulation	Check resistance				○☆				Change as necessary
Motor	Check/replace						●☆		
Pulley	Check					○☆			Change as necessary
Pressure switch	Check function					○☆			Change as necessary
After cooler	Clean					○☆			Change as necessary
O rings	Replace					●☆			Use genuine Parts
Check valve	Check function					●☆			Change as necessary
Air end fan FS-OS fin	Clean					○☆			Whenever it is Dirty
Tip & dust seals Insulation pipe Grease up	Replace					●☆			Use genuine Grease
Air end								●☆	

○ Inspect ● Replace ☆ Consult with distributor who sold it to you

\* Air intake filter is a wear part, and it is not free of charge even during warranty period. We suggest you keep it handy.

# Maintenance

- For 145psi models (SLBE-2\*H, SLBE-3H and SLBE-5H)

**Maintenance is to be done according to operating hours or period whichever comes first.**

Item	Detail	Maintenance period (every hours or period)							
		Daily	Every 400 Every 2 months	Every 2,500 yearly	Every 5,000 Every 2 years	Every 10,000 Every 4 years	Every 20,000 Every 8 years	30,000 12 years	
Drain	Air receiver	○							
Noise, vibration		○							
Air intake filter	Clean		○	●					Whenever it is dirty
Safety valve	Check function		○						
V belt	Tension/replace		○ Initial only	○		●☆			Not slack or loose
Pressure gauge	Check			○					
Magnetic switch	Check or replace				○☆	●☆			
Motor insulation	Check resistance				○☆				Change as necessary
Motor	Check or replace						●☆		
Pulley	Check					○☆			Change as necessary
Pressure switch	Check function					○☆			Change as necessary
After cooler	Clean					○☆			Change as necessary
O rings	Replace					●☆			Use genuine Parts
Check valve	Replace					●☆			Change as necessary
Air end fan FS-OS fin	Clean				○☆				Whenever it is dirty
Tip & dust seals Insulation pipe Grease up	Replace				●☆				Use genuine grease
Air end fan FS-OS fin	Clean				○☆				Whenever it is Dirty
Air end								●☆	

○ Inspect ● Replace ☆ Consult with distributor who sold it to you

\* Air intake filter is a wear part and it is not free of charge even during warranty period. We suggest you keep it handy.

# Maintenance

- How to carry out maintenance

- Intake filter

Blow dust off of it with air gun and replace if it is too dirty.

- Safety valve

Lift up stem of safety valve at around max pressure and check if air blows out.

- Belt tension

Check if V belt makes slipping sound at the startup due to decrease of V belt tension.

If so, you must readjust belt tension or replace belt.

If belt tension is less than figure in below chart, need to adjust belt tension again.

An exclusive tool is necessary to measure belt tension.

Ask our distributor to readjust belt tension when you need to readjust it.

Model	Readjustment standard load / Hz	Readjustment target load / Hz Tolerance $\pm 5$	Replacement new belt target load / Hz Tolerance $\pm 5$
SLBE-2* SLBE-3* SLBE-5*	75	98	105



# Troubleshooting guide

If you have any problems, please refer to the below chart and remedy it.

As \* marked items are difficult for you to remedy, please contact the shop you have purchased it from.

▪ Compressor

Problem	Cause	Corrective action
Compressor unit does not start	Electric source is not ON.	Turn on electric source
	Electric source is not connected correctly.	Connect it correctly
	Pressure switch is in OPEN position	Reduce pressure in air receiver
Power is at supply connection and compressor does not start	Over load relay has tripped	See last entry of Troubleshooting guide
	Wrong or low voltage	Inspect incoming power supply and unit power rating.
	Starter has failed	Inspect, repair or replace contactor assembly *
	Pressure switch has failed	Inspect, repair or replace pressure switch assembly *
	Motor has failed	Inspect, repair or replace motor *
Compressor is running but will not make pressure	Drive belts came off or too loose	Inspect, tighten or replace drive belts *
	Clogged intake filter element	Clean or replace intake filter element
	Discharge air is leaking	Inspect and repair
	Pump has failed	Inspect, repair or replace pump *
	Pump running in the wrong direction	Correct power connections
Excessive noise or vibration	Drive belt has flipped or slipped	Inspect, repair or replace drive belt *
	Motor has failed	Inspect, repair or replace motor*
	Pump has failed	Inspect, repair or replace pump
Compressor running hot	Ambient temperature is high	Be sure not to exceed above 104 degree F
	Pump running at high pressure	Check tank pressure and pump outlet are not obstructed
	After cooler fins clogged	Clean after cooler
	Clogged intake filter element	Clean or replace intake filter element
Compressor turns on/off rapidly	Receiver tank has high level of water	Drain condensate
	Check valve has failed	Inspect, repair or replace check valve *
	Pressure switch has failed	Inspect, repair or replace pressure switch *
Safety valve blows off	Motor starter contacts welded shut	Inspect, repair or replace motor starter *
	Pressure switch has failed	Inspect, repair or replace pressure switch *
Motor overload has tripped	Pump has failed	Inspect, repair or replace pump *
	Motor has failed	Inspect, repair or replace motor*
	Improper wiring	Inspect and rewire *
	Wrong overload setting	Check setting of overload relay *
	Low voltage	Check incoming power supply

# Specifications

## Compressor specifications

### 2HP

Item		SLBE-2	SLBE-2H
Max. discharge pressure	psi	115	145
Air delivery (*1)	cfm	5.3	4.5
Air outlet		NPT 1/2"	
Operating voltage		(1Phase, 115/208-230V, 60Hz) 3Phase, 208-230/460V, 60Hz	
Dimensions (LxWxH) (*2)	In.	43 x 22 x 21	43 x 22 x 21
Approx. mass	Lbs.	270	270

\*1. Air delivery means average discharge air volume at the maximum operating pressure converted into atmospheric pressure. It is not a warranted figure.

\*2. Dimensions is outer dimensions excluding extruding parts.

### 3HP

Item		SLBE-3	SLBE-3H
Max. discharge pressure	psi	115	145
Air delivery (*1)	cfm	7.8	6.4
Air outlet		NPT 1/2"	
Operating voltage		3Phase, 208-230/460V, 60Hz	
Dimensions (LxWxH) (*2)	In.	43 x 22 x 21	43 x 22 x 21
Approx. mass	Lbs.	285	285

\*1. Air delivery means average discharge air volume at the maximum operating pressure converted into atmospheric pressure. It is not a warranted figure.

\*2. Dimensions is outer dimensions excluding extruding parts.

### 5HP

Item		SLBE-5	SLBE-5H
Max. discharge pressure	psi	115	145
Air delivery (*1)	cfm	14.8	11.7
Air outlet		NPT 1/2"	
Operating voltage		3Phase, 208-230/460V, 60Hz	
Dimensions (LxWxH) (*2)	In.	43 x 22 x 21	43 x 22 x 21
Approx. mass	Lbs.	310	310

\*1. Air delivery means average discharge air volume at the maximum operating pressure converted into atmospheric pressure. It is not a warranted figure.

\*2. Dimensions is outer dimensions excluding extruding parts.

# Appendix

- Outer dimensions
  - SLBE-2\*\*, SLBE-3\* and SLBE-5\*

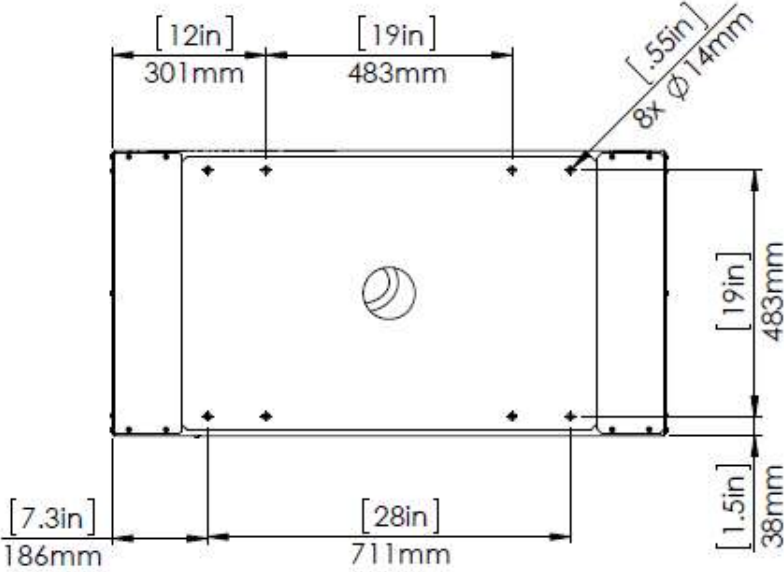
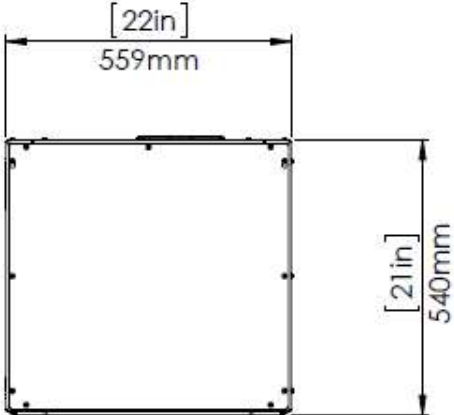
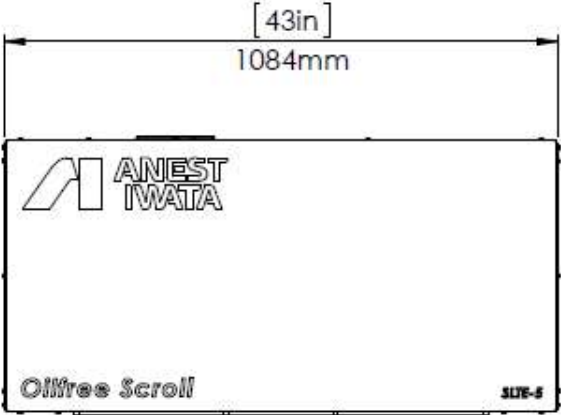



# Appendix

- SLBE-2-S208-230, SLBE-3-S208-230 and SLBE-5-S208-230

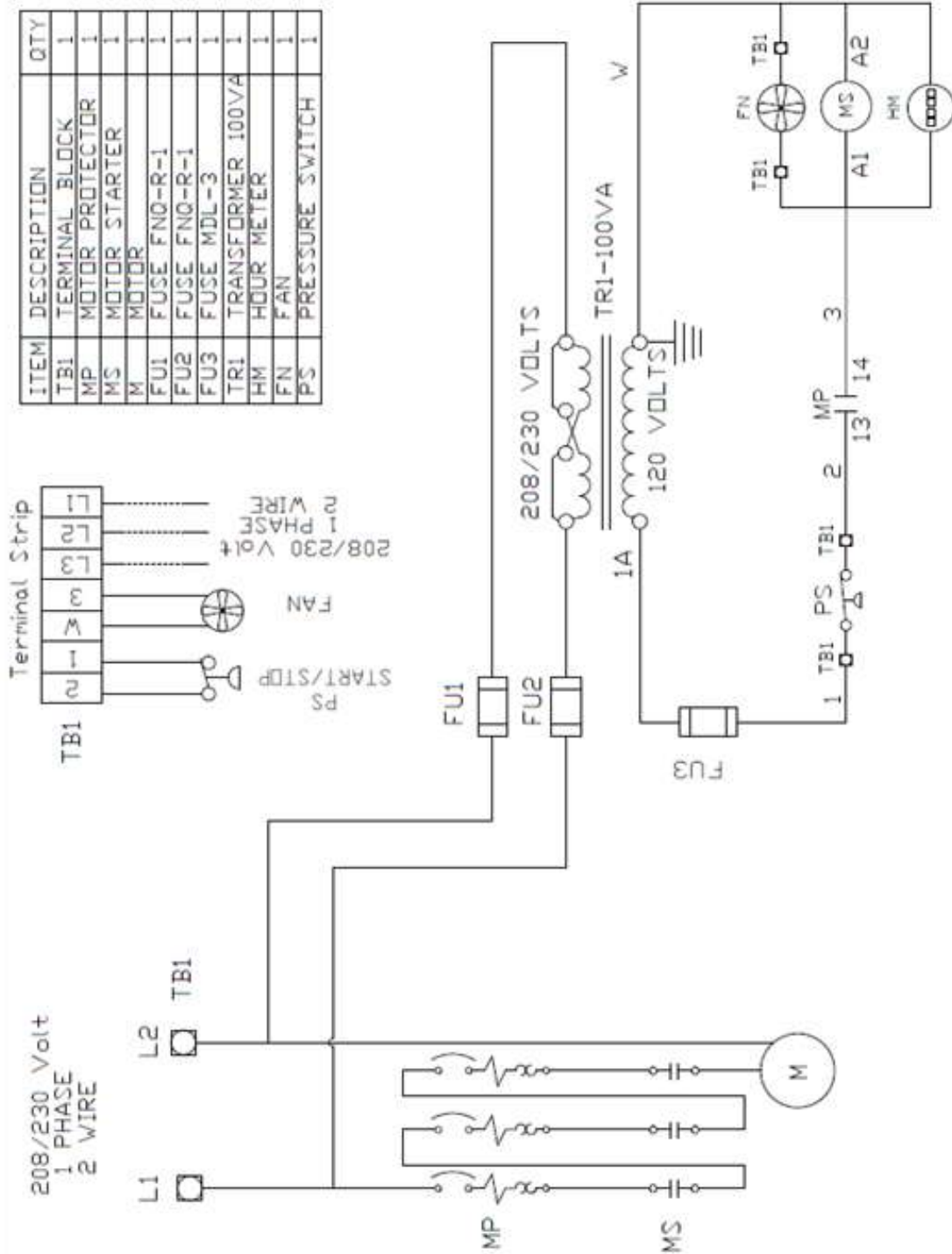

# Appendix

- SLBE-2-T208-230/460, SLBE-3-T208-230/460 and SLBE-5-T208-230/460

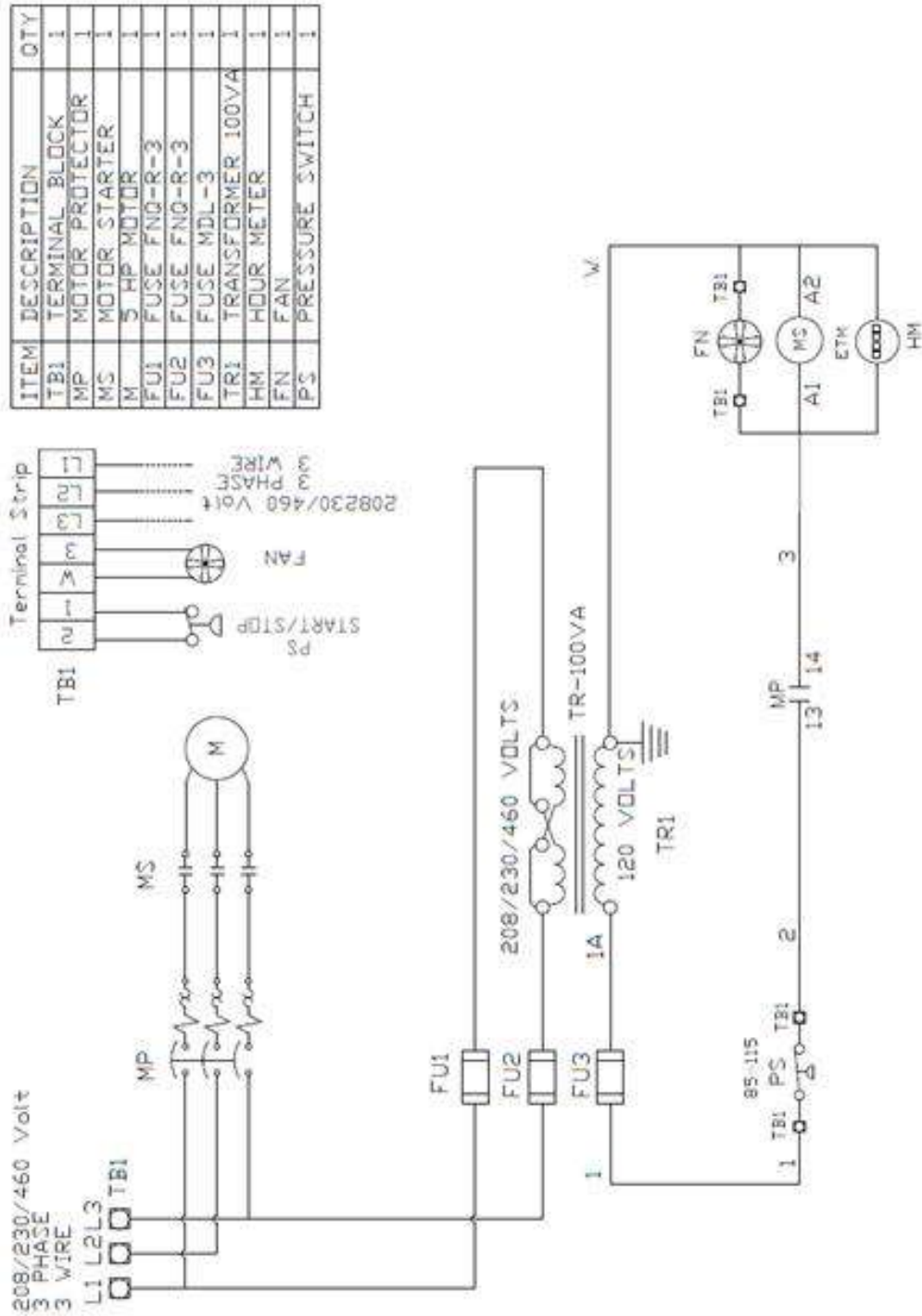

# Warranty

## ■ Compressor Warranty and Remedies

- (a) **General.** Anest Iwata - Air Engineering warrants each Compressor System, Compressor Air-End, or Anest Iwata branded accessory (collectively “products”; individually each a “product”) to be free from defects in material and workmanship (“Defects”) at the date of shipment. EXCEPT AS SET FORTH BELOW, NO OTHER WARRANTY, WHETHER EXPRESS OR IMPLIED, INCLUDING ANY WARRANTY OF MERCHANTABILITY OR FITNESS FOR A PARTICULAR PURPOSE, SHALL EXIST IN CONNECTION WITH THE SALE OR USE OF SUCH PRODUCTS. TO THE EXTENT PERMITTED BY LAW ANY AND ALL IMPLIED WARRANTIES ARE EXCLUDED. All claims under this warranty must be made in writing and delivered to Anest Iwata Air Engineering, or such claim shall be barred. Upon timely receipt of a claim, Anest Iwata Air Engineering shall inspect the product claimed to have a defect, and Anest Iwata Air Engineering shall repair, or, at its option, replace, free of charge, any product which it determines to have had a defect at the time of shipment from Anest Iwata Air Engineering; provided, however, that if circumstances are such as to preclude the remedying of defect by repair or replacement, Anest Iwata Air Engineering shall, upon return of the product, refund to buyer any part of the purchase price of such products paid to Anest Iwata Air Engineering. Freight for the returning products to Anest Iwata Air Engineering for inspection shall be paid by buyer. The warranties and remedies herein are the sole and exclusive remedy for any breach of warranty or for any other claim based on any defect, or non-performance of the products, whether based upon contract, warranty or negligence.
- (b) **Initial period of warranty – Parts and Labor.** Anest Iwata Air Engineering warrants and represents all products shall be free from defects for the first twelve (12) months from the date of shipment by Anest Iwata Air Engineering, or five thousand (5,000) hours of use, whichever occurs first. During such warranty period, Anest Iwata Air Engineering shall be fully liable for all defects in the products (the “product defects”), i.e., all costs of repair or replacement, which may include “in and out” charges, so long as the products are located in the continental United States, and the products are reasonably located and accessible by service personnel for removal. “In and out” charges include the costs of removing a product from buyer’s equipment for repair or replacement.
- (c) **Additional period of Warranty – Parts Only (No Labor).** In addition to the above, Anest Iwata Air Engineering warrants each Anest Iwata branded compressor air-end, shall be free of defects for a period of eighteen months from the date of shipment of product, or 10,000 hours of use, whichever occurs first. Supplier’s repair or replacement of any product shall not extend the period of any warranty of any product. This warranty applies to the exchange of part(s) found to be defective by an authorized Anest Iwata service center only.
- (d) **Coverage.** The above mentioned warranty applies to Anest Iwata Air Engineering manufactured units or systems only.
- (e) **Exceptions.** Notwithstanding anything to the contrary herein, Anest Iwata Air Engineering shall have no warranty obligations with respect to products:
- (i) That have not been installed in accordance with Anest Iwata Air Engineering’s Written specifications and instructions;
  - (ii) That have not been maintained in accordance with Anest Iwata Air Engineering’s written instructions;
  - (iii) that have been materially modified without the prior written approval of Anest Iwata Air Engineering; or
  - (iv) That experience failures resulting from operation, either intentional or otherwise, in excess of rated capacities or in an otherwise improper manner.
- (f) The warranty provided herein shall not apply to: (i) any defects arising from corrosion, abrasion, use of insoluble lubricants, or negligent attendance to or faulty operation of the products; (ii) ordinary wear and tear of the products; or (iii) defects arising from abnormal conditions of temperature, dirt or corrosive matter; (iv) any OEM component which is shipped by Anest Iwata Air Engineering with the original manufacturer’s warranty, which shall be the sole applicable warranty for such component.

**Limitation of liability.** TO THE EXTENT ALLOWABLE UNDER APPLICABLE LAW, NOT WITHSTANDING ANYTHING TO THE CONTRARY HEREIN, UNDER NO CIRCUMSTANCES SHALL ANEST IWATA AIR ENGINEERING BE LIABLE FOR ANY INCIDENTAL, CONSEQUENTIAL, PUNITIVE, SPECULATIVE OR INDIRECT LOSSES OR DAMAGES WHATSOEVER ARISING OUT OF OR IN ANY WAY RELATED TO ANY OF THE PRODUCTS OR GOODS SOLD OR AGREED TO BE SOLD BY ANEST IWATA AIR ENGINEERING TO BUYER. TO THE EXTENT ALLOWABLE UNDER APPLICABLE LAW, ANEST IWATA AIR ENGINEERING’S LIABILITY IN ALL EVENTS IS LIMITED TO AND SHALL NOT EXCEED THE PURCHASE PRICE PAID.

**Warranty Disclaimer.** Anest Iwata Air Engineering has made a diligent effort to illustrate and describe the products in this literature accurately; however, such illustrations and descriptions are for the sole purpose of identification, and do not express or imply a warranty that the products are merchantable, or fit for a particular purpose, or that the products will necessarily conform to the illustrations or descriptions.

**Product Suitability.** Many jurisdictions have codes and regulations governing sales, construction, installation, and/or use of products for certain purposes, which may vary from those in neighboring areas. While Anest Iwata Air Engineering attempts to assure that its products comply with such codes, it cannot guarantee compliance, and cannot be responsible for how the product is installed or used. Before purchase and use of a product, please review the product applications, and national and local codes and regulations, and be sure that the product, installation, and use will comply with them.

**Claims.** Claims pertaining to the products, with the exception of warranty claims, must be filed with Anest Iwata Air Engineering within 6 months of the invoice date, or they will not be honored. Prices, discounts, and terms are subject to change without notice or as stipulated in specific product quotations. All agreements are contingent upon strikes, accidents, or other causes beyond our control. All shipments are carefully inspected and counted before leaving the factory. Please inspect carefully any receipt of products noting any discrepancy or damage on the carrier’s freight bill at the time of delivery. Discrepancies or damage which obviously occurred in transit are the carrier’s responsibility and related claims should be made promptly directly to the carrier. Returned products will not be accepted without prior written authorization by Anest Iwata Air Engineering and deductions from invoices for shortage or damage claims will not be allowed. **UNLESS OTHERWISE AGREED TO IN WRITING, THESE TERMS AND CONDITIONS WILL CONTROL IN ANY TRANSACTION WITH ANEST IWATA AIR ENGINEERING** Any different or conflicting terms as may appear on any order form now or later submitted by the buyer. All orders are subject to acceptance by Anest Iwata Air Engineering.

Anest Iwata Air Engineering 5325 Muhlhauser Road, Hamilton, Ohio 45011 USA 800-440-0282



ANEST IWATA AIR ENGINEERING, Inc.

[www.anestiwata.com](http://www.anestiwata.com)

[inquiry@anestiwata.com](mailto:inquiry@anestiwata.com)

Toll Free (800)440-0282

No.SLBE5-99\_rev3.0