

Back view

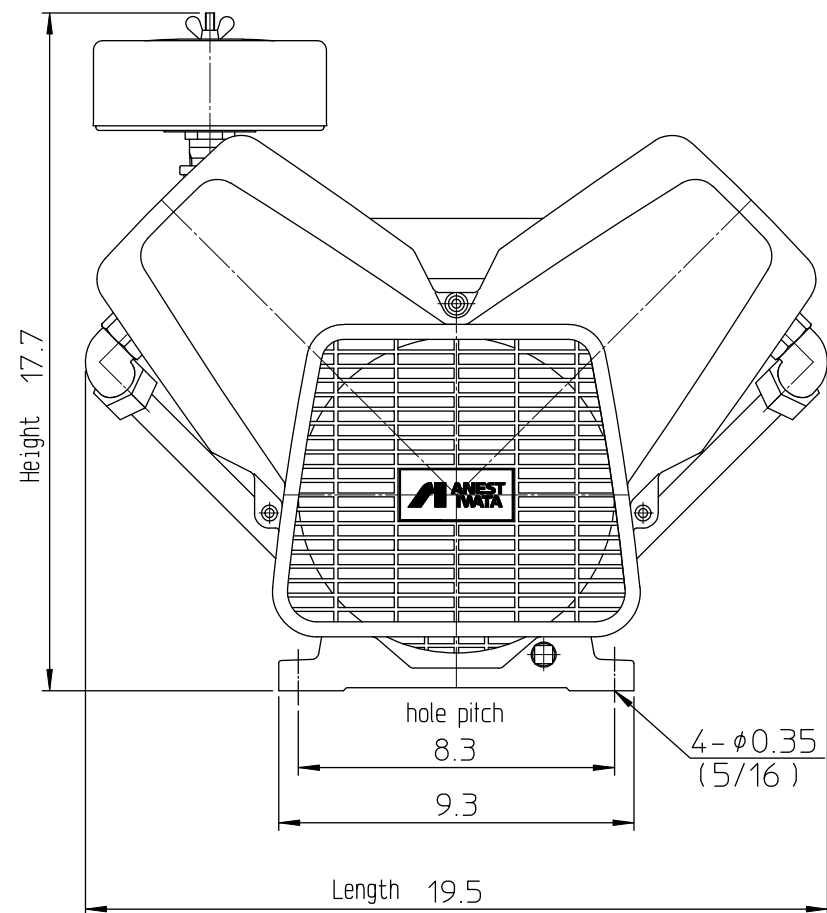

Front view

Model		F22BP-10-US
Pump number		F22BP-10-S80
Stage number		1
Compressor power	HP	3
Maximum allowable pressure	psi	145
Free air delivery @ 120 psi	cfm	5.7
Weight	lb	46.3
Approx. net dimensions Length x Width x Height	inch	19.5 x 13.4 x 17.7

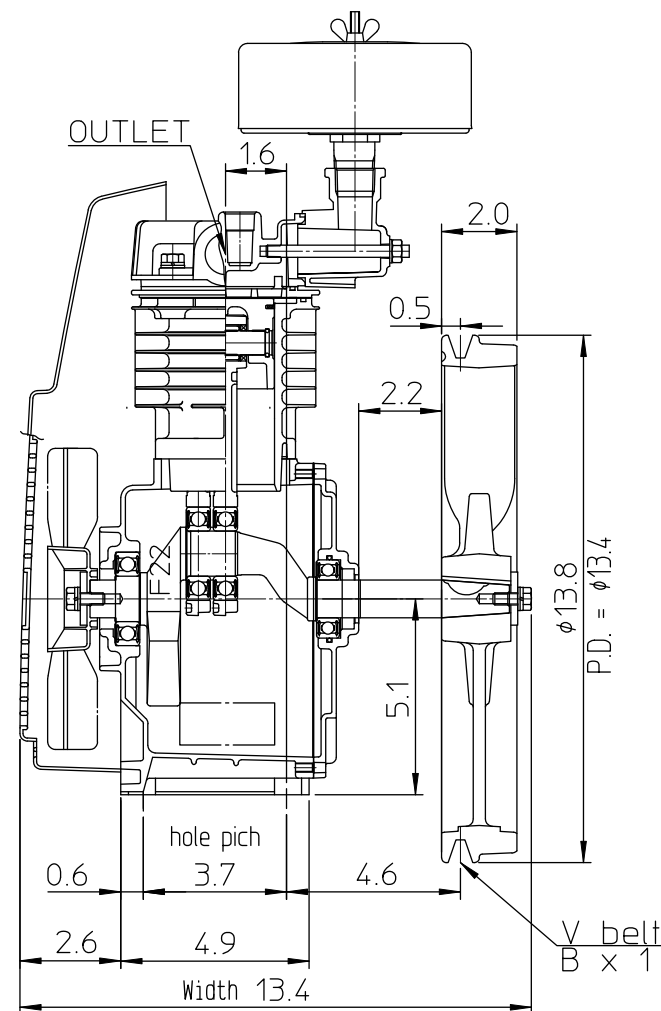

Perspective side view

UNIT	inch	SCALE	1 : 5	CAD-C
MODEL	F22BP-10-US			
NAME	Oil less piston Compressor			
CODE No.	F22BP-10-US-301			
APP	ENG	CHE	DRA	
032514	032514	032514	032514	
A.Shirai	T.Tomita	T.Tomita	T.Tomita	
DATE	03 / 25 / 2014			
ANEST IWATA Air Engineering, Ltd.				