

Back view

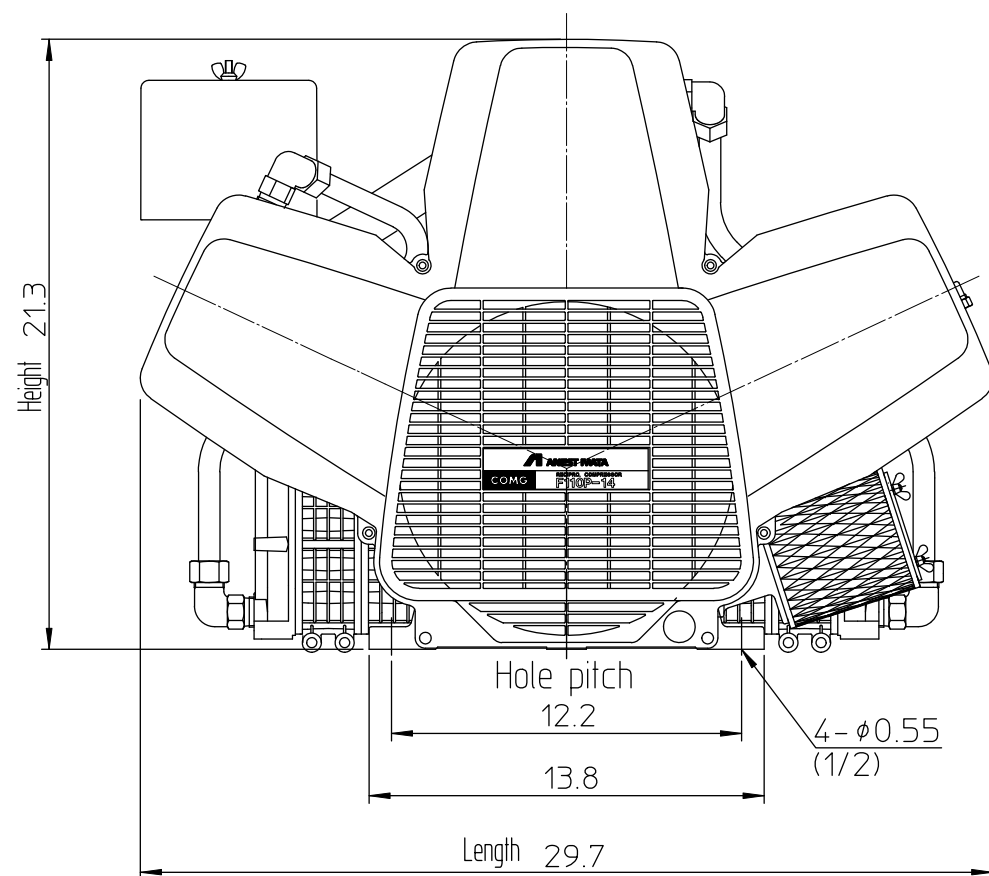

Front view

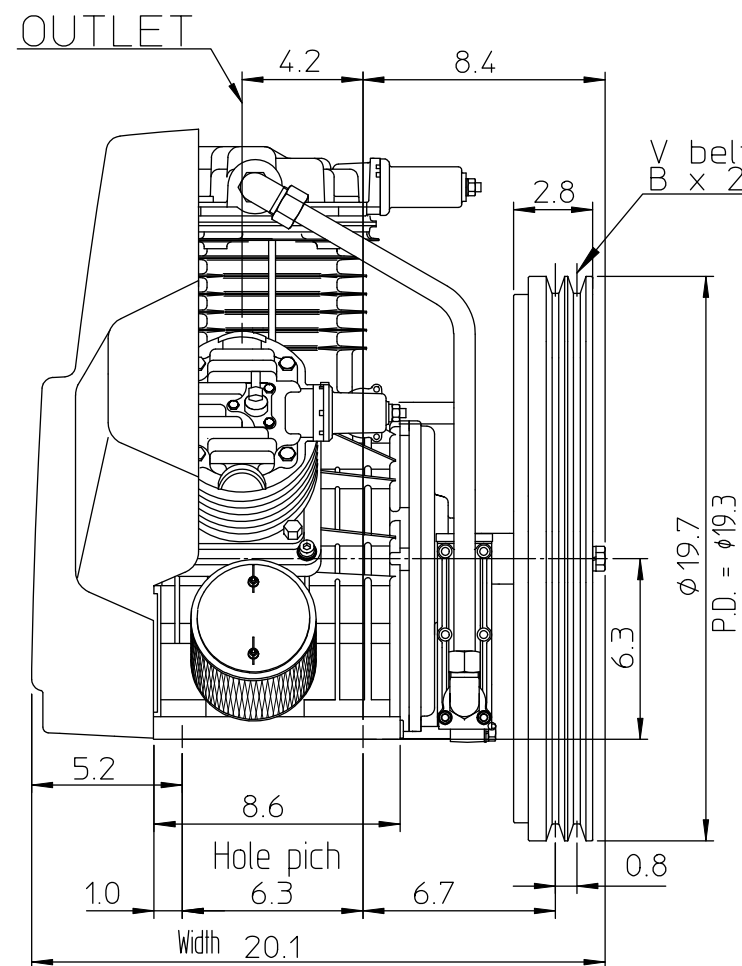

Side view

Model		F110P-14-US
Pump number		F110P-14-S80
Stage number		2
Compressor power	HP	15
Maximum allowable pressure	psi	200
Free air delivery @ 200 psi	cfm	37.3
Free air delivery @ 120 psi	cfm	40.3
Weight	lb	141.1
Approx. net dimensions Length x Width x Height	inch	29.7 x 20.1 x 21.3

UNIT	inch	SCALE	1 : 7	CAD-C
MODEL	F110P-14-US			
NAME	Oil less piston compressor			
CODE No.	F110P-14-US-301			
APP	ENG	CHE	DRA	
032514	032514	032514	032514	
A.Shirai	T.Tomita	T.Tomita	T.Tomita	
DATE	03 / 25 / 2014			
ANEST IWATA Air Engineering, Ltd.				